



Industrial 3-D Surveying

with Optical Instruments



Wagon Construction



Shipbuilding



General Steel and
Plant Construction



Aircraft Construction



Antenna Construction



Pipeline Building



Construction
Machinery
Engineering



Wind Energy



Paper Machines



Monitoring

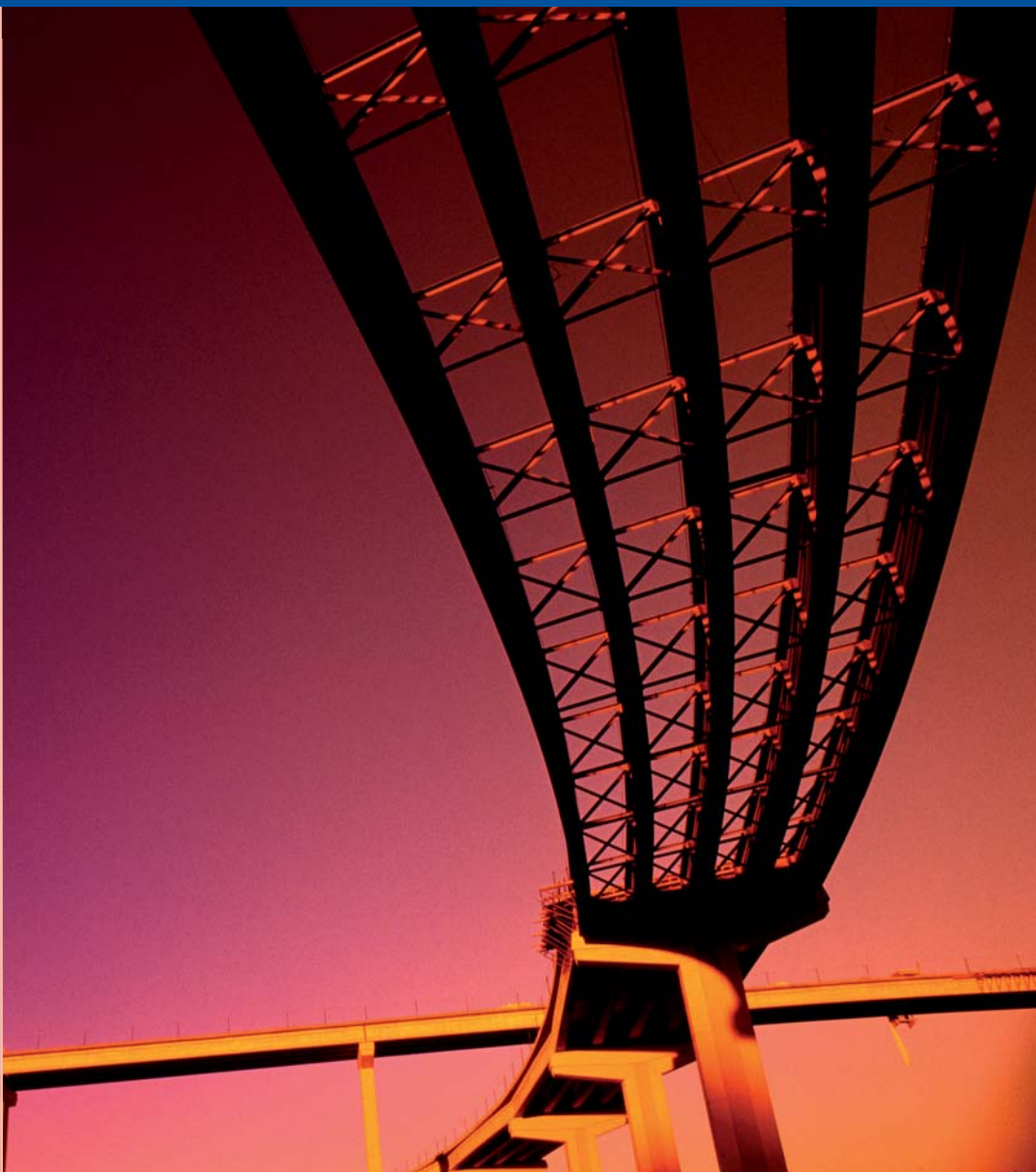

About Us

GLM: The Company

GLM was founded in 1991. Today, the company has settled in the technology park Indu-Tec in the town of Witten. Our activities are primarily focused on optical 3-D surveying and measuring. As a partner of the company Sokkia, we are providing customized complete systems and assistance to industrial customers across all of Europe. Our engineering team, modern in-house production facilities with state-of-the-art equipment, as well as close cooperation with the Bochum University contribute to our unique ability to realize flexible and reasonably priced solutions. Our own mobile fleet of measuring and surveying equipment is also available for surveying tasks commissioned by our customers – around the clock and without geographical restrictions!



GLM - Office in Witten

Development among Partners

The GLM professional philosophy strives to find the optimal system configuration for the planned application by working closely with the customer. Intensive and in-depth collaboration, for example with major companies in the rail and ship building industry, have allowed for the steady growth of our product and service portfolio. We are always interested in new and challenging tasks.

Software and Application Development

To increase the benefit our customers can reap from investing in our software, we are constantly expanding our target adaptors to provide cost-efficient measuring and survey options for any requirement. The GLM Software Team develops macros for special analysis specifications. Measuring-sheets and documents are generated automatically. Our 3-DIM group of software is continuously adapted and improved to meet the needs of our customers.

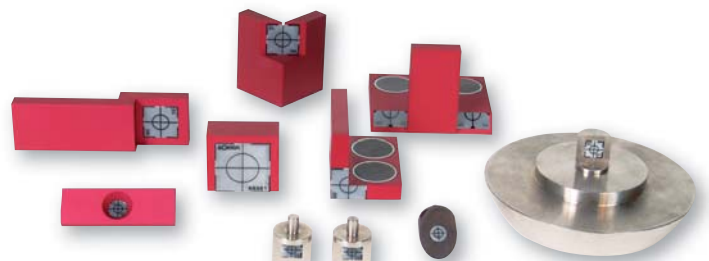

Selected Targets

Training

Training is usually conducted directly at the production facilities of our customers. This allows us to target specific tasks and requirements and conduct highly practical and hands-on training.

Support

Our support continues when the training session ends. We gladly help you with any questions you may have when you contact us by phone. Our support team is available during office hours.

Contract

Measurement

Our expert measurement-team is available for you, worldwide.

Service

You call us and we organize a maintenance interval that is as brief as possible. Should you require an instrument during the maintenance period, our instruments for lease are at your disposal.

The 3-DIM Group of GLM Software

Sokkia Total Stations can be controlled with the 3-DIM PC-Basic desktop version or the robust 3-DIM Observer data logger. The control unit 3-DIM Observer Motorized was developed for motorized stations. Numerous CAD applications can be linked with the provided interface for a comprehensive flow of data.

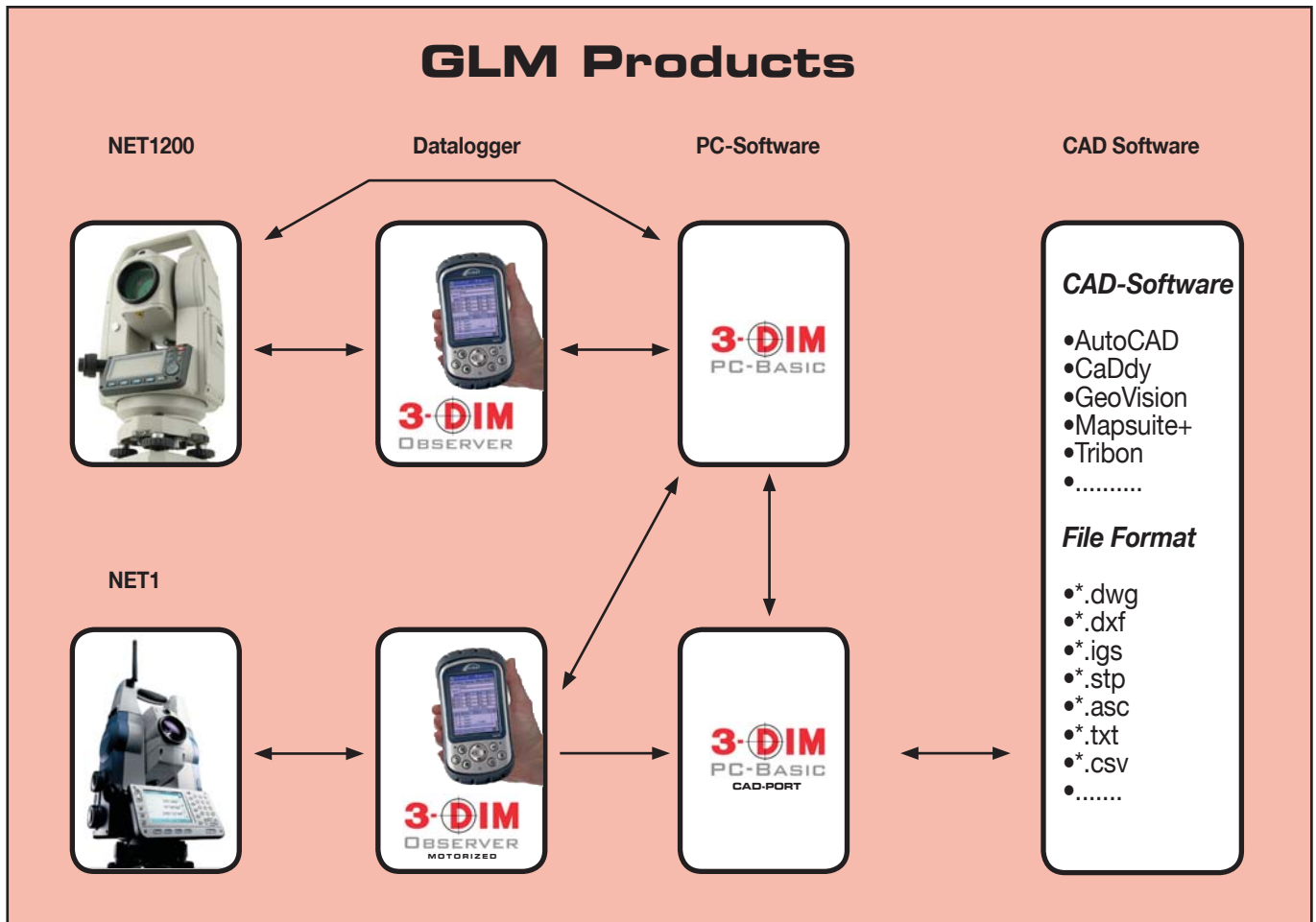

3-DIM PC-Basic



PC software for 3-D measurements and analyses in industrial applications

3-DIM PC-Basic is an excellent program for industrial surveying and measuring tasks. Shipbuilders, railway engineers, bridge builders and other engineers consider 3-DIM PC-Basic an indispensable tool for preparing and documenting geometrical measurements.

Since its first version in 1993, 3-DIM PC-Basic was continuously enhanced based on suggestions by our customers, new industry requirements, and the experiences of the GLM industrial survey team.

Flexible

3-DIM PC-Basic supports different working methods:

- Measuring individual objects without test planning (freeform measuring).
- Measuring nominal data with immediate visualization of the nominal-actual deviation. Values exceeding the tolerance setting are especially emphasized. CAD data can be imported with the help of the optional 3-DIM CAD-Port.
- Measurements based on templates speed up repetitive measuring processes (series production). Software macros allow the automatic determination of the reference coordinates and calculating dimensions.
- 3-DIM PC-Basic supports the direct control of the tachymeter or data exchange with electronic field PCs (handhelds).

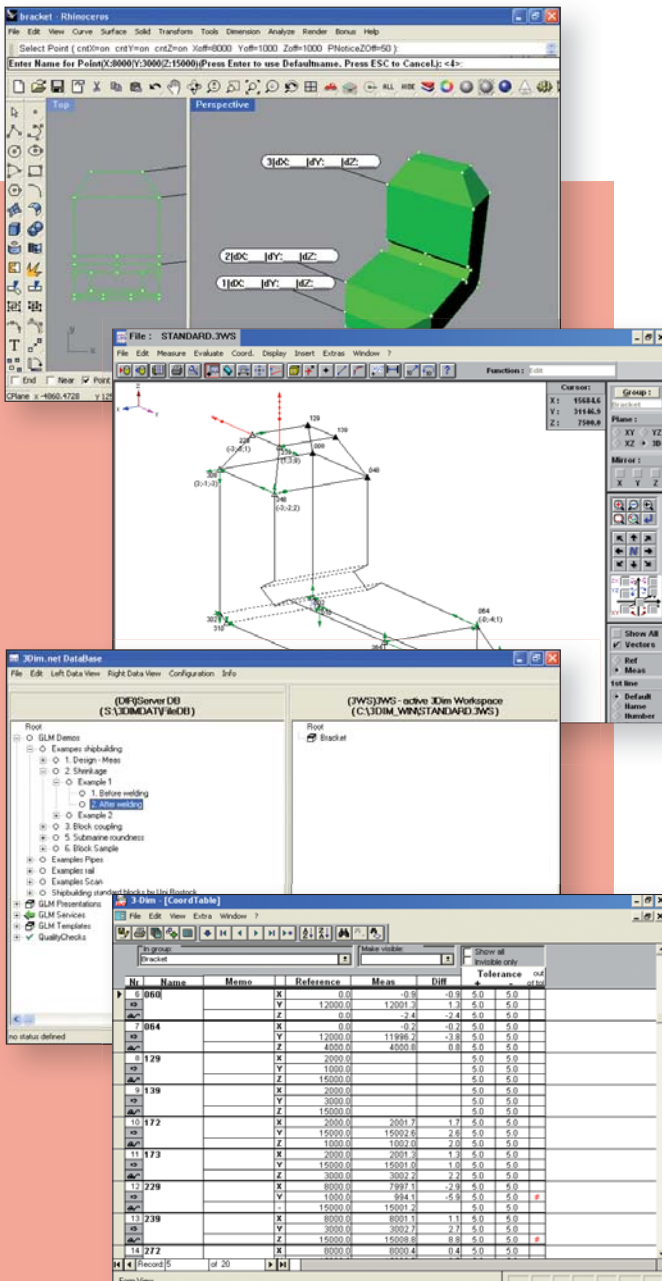

Industrial motorized Station on site

Perfect Visualization

- Graphical and numerical data display.
- Error vectors depict size and direction of the deviation.
- Display options are customizable to specific needs.

Example:

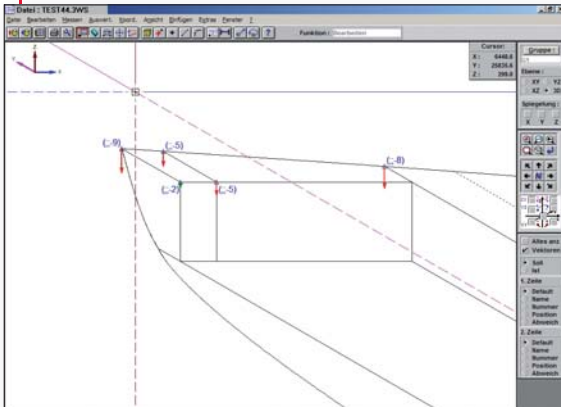

Deviation between reference (nominal) and measured (actual) value

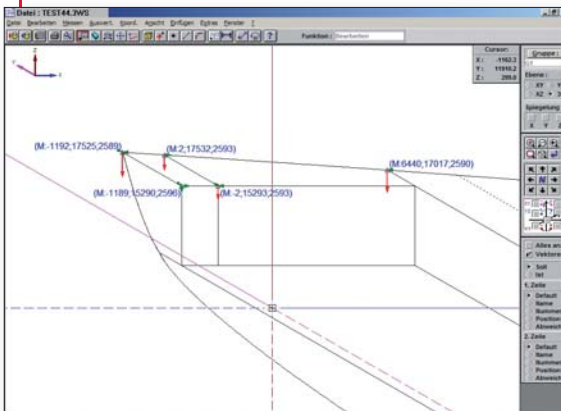

Measured coordinates

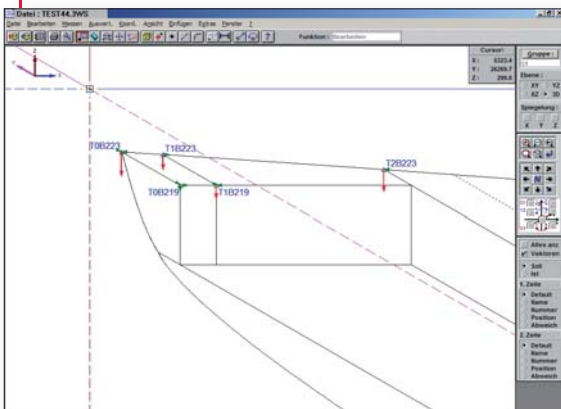

Name of measuring points

Additional Data Processing

- The integrated database makes it possible to exchange data while linked with the network.
- Data from different sources (3-DIM files, PDF, Word, Excel, etc.) can be stored together in the same database.
- The 3-DIM data access component and an XLA file expand the Excel functionality for easy access to 3-Dim data.
- Export to ASCII, Excel, DBase, DXF
- Import almost any other file format from ASCII files.

Analysis

The following analyses are available when clicking on the points in the graphic:

- Position
- Distance
- Distance Point – Line
- Intersection Point
- Angle, 3 Points
- Angle, 2 Lines
- Circle
- Line
- Center Point

Example: Distance between two points:
Calculates [X], [Y], and [Z] distance, spatial distance and in the projection planes based on the current system of coordinates.

All results can be stored in a log file.

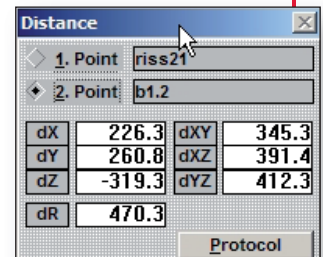

Example: Circle:
Center of a circle, normal vector, and concentricity deviations are calculated from 3 or more points. The deviations can be depicted in the graphic or the log.

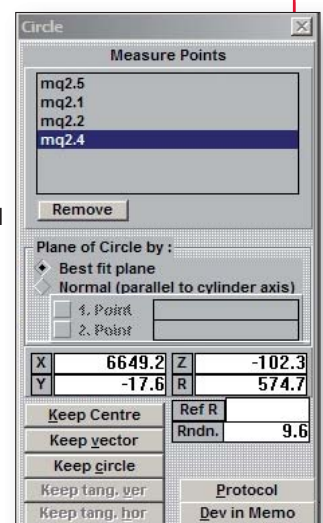

3-DIM User Interface

A part of the ship section was already measured in this example. Measured points (Δ) are depicted differently than those that still have to be measured (\blacktriangle). When using a field PC, the printout of the graphic helps the surveyor to identify the measuring points more easily. 3-DIM PC-Basic is available in different languages.



Surveying the world's largest telescopic crane

Alignment and Coordinate Transformations

The data can be transformed to the desired system of coordinates at any time (also during measurements). All additional measuring points are then also imported to this system of coordinates.

The alignment of the actual values within the object coordinate system can be carried out with the corresponding nominal values. Manual, detail alignment (rotating or shifting in small increments) is also easily possible. The optional Tolerance Optimizer minimizes the number of tolerance overranges. This prevents or reduces the need for repairs.

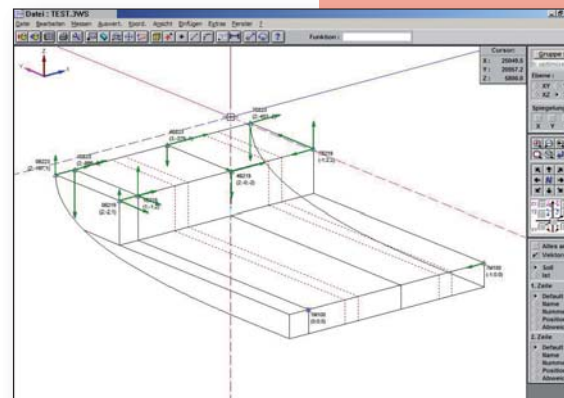

Example: Graphic

Nr	Bezeichner	Memo	Soll	Ist	Differenz	Toleranz	Überschreit
1	T1M100	Origin	X 0,0	-0,3	-0,3	4,0	4,0
			Y 0,0	0,0	0,0	4,0	4,0
			Z 0,0	4,8	4,8	4,0	4,0
2	T8M100	x-Axis	X 30571,5	30571,8	0,4	4,0	4,0
			Y 0,0	0,0	0,0	4,0	4,0
			Z 0,0	0,8	0,8	4,0	4,0
3	T0B219		X -1191,5	-1188,6	-2,9	4,0	4,0
			Y 15291,0	15280,1	-10,9	4,0	4,0
			Z 2588,0	2600,6	2,6	4,0	4,0
4	T0B223		X -1191,5	-1192,2	-0,7	4,0	4,0
			Y 17527,0	17525,2	-1,8	4,0	4,0
			Z 2588,0	2584,0	-4,0	4,0	4,0
5	T1B219		X 0,0	-1,8	-1,8	4,0	4,0
			Y 15291,0	15293,4	2,4	4,0	4,0
			Z 2588,0	2587,9	-0,1	4,0	4,0
6	T1B223		X 0,0	2,4	2,4	4,0	4,0
			Y 17330,0	17531,6	201,6	4,0	4,0
			Z 2588,0	2587,4	-0,6	4,0	4,0
7	T2B213		X 6440,0	6440,8	0,8	4,0	4,0
			Y 10215,0	10215,0	0,0	4,0	4,0
			Z 2588,0	2602,0	14,0	4,0	4,0

Example: Table

Coordinate Transformations

Point-clicking in graphics enables following analysis:

- Shift -> Value
- Shift -> Origin
- Shift -> Relative
- Rotate -> Value
- Rotate -> 2(3) points
- Rotate -> 2 lines
- 3-D alignment
- Actual->nominal alignment 1-3 points
- Plane 3-n points

Example: Plane 3-n points

Uses the least square fit calculation method to determine the compensation plane across at least 3 points and enables coordinate transformations based on this calculation.



Shipbuilding in application

to 3-DIM PC-Basic just with a mouse-click. This method makes it possible to generate rather useful test sketches. The test results can be imported from 3-DIM PC-Basic to 3-DIM CAD-Port after the measuring process. This tool documents your results in a clearly arranged, easy to read outline.

3-DIM Optimizer

A mathematical heuristic optimizer minimizes the number of tolerance overranges by shifting and rotating the system of coordinates. This works even if the measuring points feature different tolerances in the different coordinate axes.

Options

A selection of optional program enhancements round out the application spectrum of 3-DIM PC-Basic:

3-DIM CAD-Port

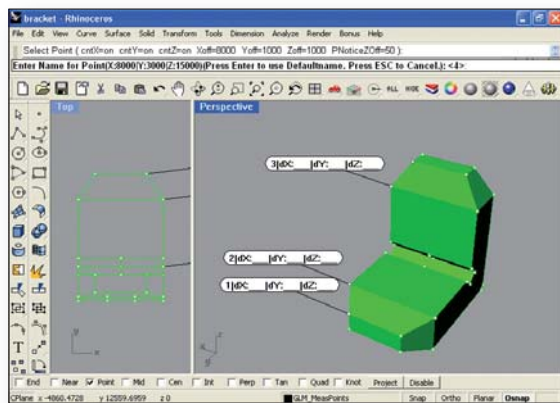

3-DIM CAD-Port

The new GLM interface between 3-DIM PC-Basic and CAD makes it possible to generate measuring points with nominal coordinates and simplified graphics from files created by different CAD systems.

3-DIM CAD-Port is a very comprehensive interface between 3-DIM PC-Basic and the most commonly used CAD formats. Use the 3-DIM CAD-Port module to select your points to be checked from predefined reference points and copy them easily and quickly to 3-DIM PC-Basic. The line connection required for the geometric views are also exported

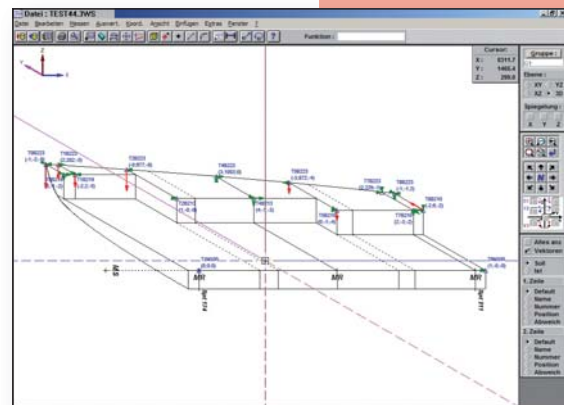

Deviations before optimizing

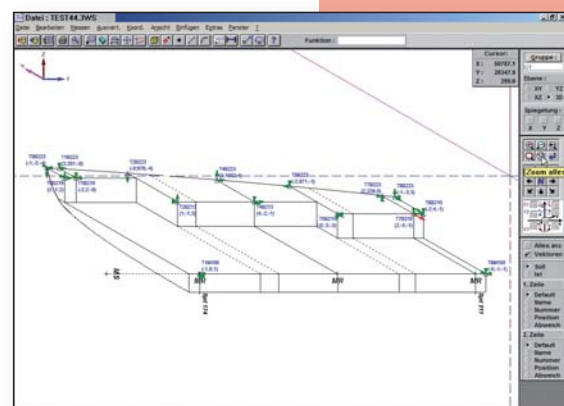

Deviations after optimizing

3-DIM Observer

The GLM Field PC for the SOKKIA Precision Total Stations

Many years of experience in the field of industrial optical coordinate survey technology as well as numerous suggestions of our customers have been incorporated into the development of the software for this new data logger.

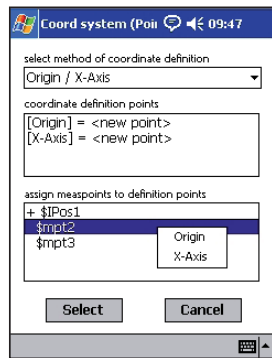

Example: Transformation

Overview of the 3-DIM OBSERVER Advantages:

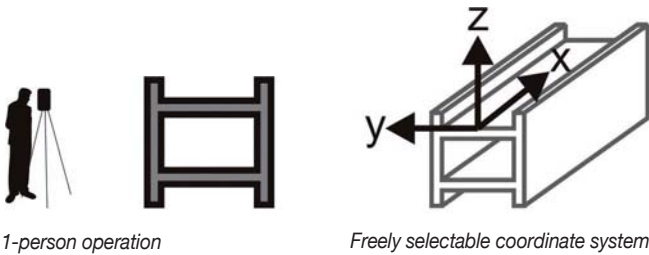

The measuring sequence is unimportant when defining the desired system of coordinates. The system of coordinates can be defined at any time (during or after the measurement) by simply selecting the definition points from a point list. All measuring points are immediately depicted in the current system. The points selected for defining the system of coordinates are marked in the point lists and are thus easily identified later. The definition points for a system of coordinates are frequently not located directly along the axes but are shifted by certain offsets. These offsets can be entered directly. Offsets are automatically considered and applied (even if the system of coordinates has not yet been defined).



Easy Measurements

MEAS	REF	DIFF	OFF
X	5295.7	5300.0	-4.3
Y	4.9	5.0	-0.1
Z	-3.0	0.0	-3.0

Example: Basic screen

Point names can be :
 entered alphanumerically; selected from a list with design data;
 incremented automatically or generated completely automatically.

“One-Click Measurement”

Measurements can be triggered with just one key. This means a great timesaving, especially when logging large amounts of points.

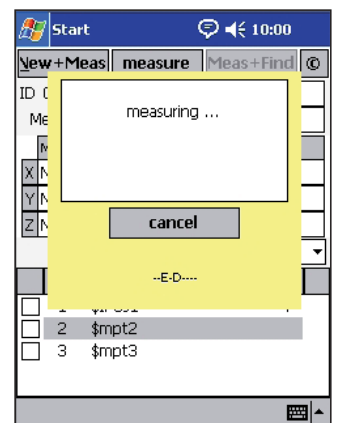

Example: Measurement

Measuring Methods

- In addition to logging simple points, it is also possible to define the center points of circles, for example. The calculated points are also available for defining coordinate systems.

Design Data Measurement

- Measured values are immediately compared with existing nominal data, deviations are calculated automatically, points out of tolerance are displayed.
- Nominal data can be entered manually or loaded from PC in the form of a nominal data record.
- Additional measuring points without nominal data coordinates can be added at any time.

Selecting Targets

- Targets (single, double, and offset targets) are selected from a target list during the measurement. Reflectorless, exact dimensioning of edge positions is possible by selecting 2- or 3-point excenter targets. New target types can be generated and saved at any time. The use of target types is not subject to any restriction. Any type can be used to log the definition points for the system of coordinates as well.

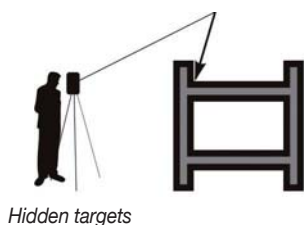

Target Editor 09:50

Name: New Target

Reflector type: PrismConstant

Sheet: 0.0

Target Type: Targets

Single

Preset Offset: x: 0.0, y: 0.0, z: 0.0

Buttons: apply, select, edit, close

Example: Target editor

Free Station-Points for “Around-Measurements”

- Changing the location of the Total Station is easily done at any time, e.g. also at a time when not all definition points to define the coordinate system have been logged yet.
- Two known measuring points are usually sufficient for this purpose. For example, shipbuilding requires only two known measuring points to determine the locations along a tilted plane (slipway slope).
- In combination with precision-target RT1A, only one known point is required.
- Three known measuring points are required only if the tilt compensator is switched off (e.g. floating ship).



Change instrument station

Example: Change instrument station analysis

Change Instrument Po 13:56

Differentials of coordinate link.

Name	dX	dY	dZ
point1	-0.49	0.11	0.74
point2	0.39	-0.26	0.50
point3	0.10	0.16	-1.24

mean deviation : Sp=0.718

close

Measuring Control Points

- Existing measured values can be used as nominal data for additional measurements (typical use: machine alignment, comparison of associated points, control measurements at end of a measuring phase).

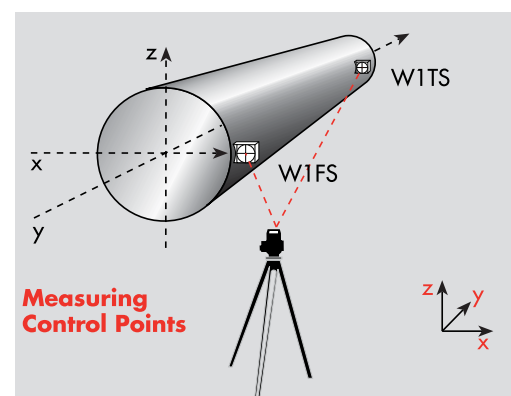

Roller alignment

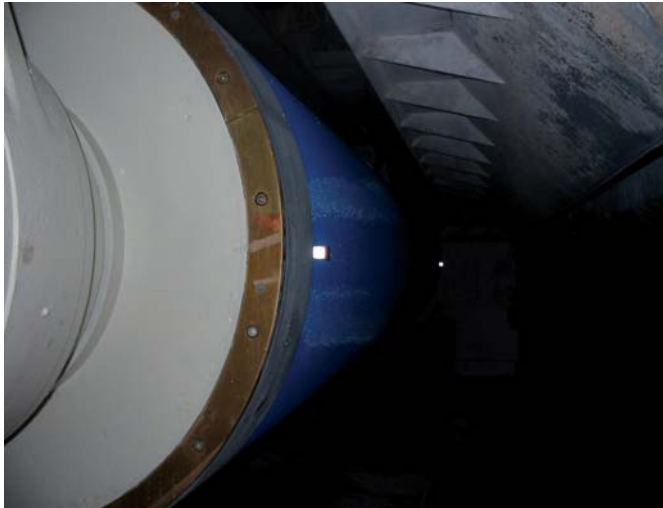

Paper Machine

Measuring with Templates

- A template can contain the once logged reference points within a workshop or dock, for example. When measuring with this template, a simple location change can establish the connection with the measuring coordinate system even if the coordinate reference points are no longer visible, e.g. due to the building progress of a ship or a machine.
- With repetitive measurements of series components, a template contains all points to be logged including designations and nominal values. The points list provides clear information about which points have been measured already and which are yet to be logged. The use of templates is especially helpful if automated analyses (macros) are to be carried out after transferring the data to a PC.
- Measurements do not change or affect a template, which means it can be reused countless times. Each measuring data record can be saved as a template.

Easy Stake-out of Points and Axes

- Based on existing nominal coordinates, the user receives a clear specification for the quick setting of the desired point. If the Total Station is equipped with a laser pointer, the nominal position is marked precisely.
- By outputting the axis-related instrument angles, the utilized instrument (with free positioning) can be exactly parallel to an axis of the system of coordinates.

This simplifies the alignment of machine elements. This mode is similar to using a theodolite but without having to focus the instrument onto a reference line.

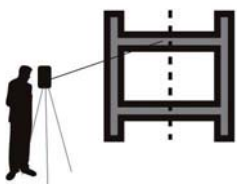

Axes stake out

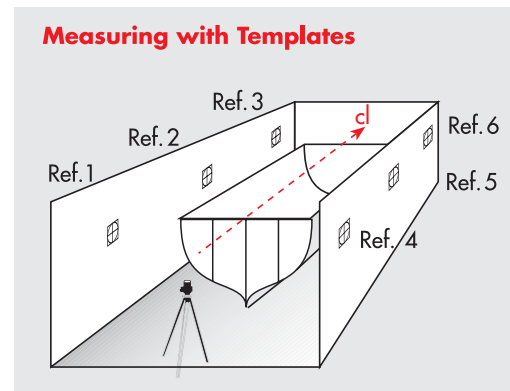

Ship in dock

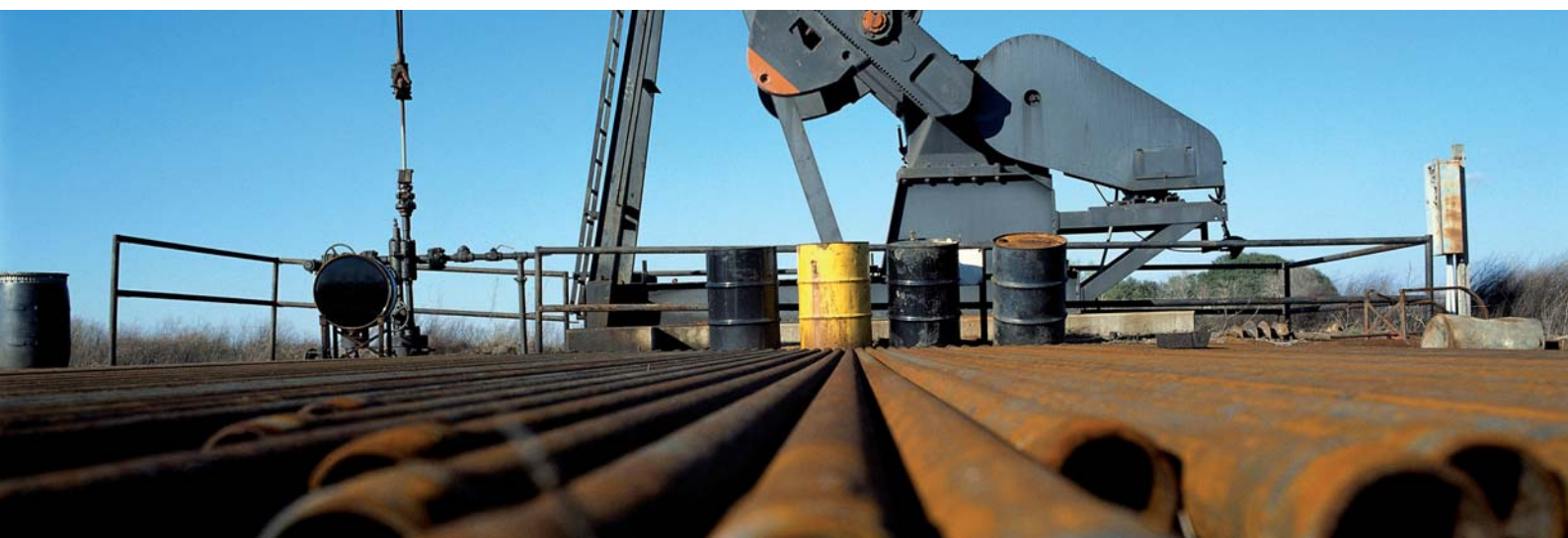

Analysis Functions

You can access existing points or measure new points within the scope of the analysis functions. The following modules are implemented:

- Distances between 2 points
- Distance point – straight line
- Intersections between two straight lines
- Angles between 3 points
- Angles between 2 straight lines
- Individual and total area calculation
- Analysis of planes of a spatial area
- Flange and cylinder calculations
- Circle calculations (rotundity checks)
- General center point generation
- Documentation of point attributes
- Merging various point coordinates to one new point

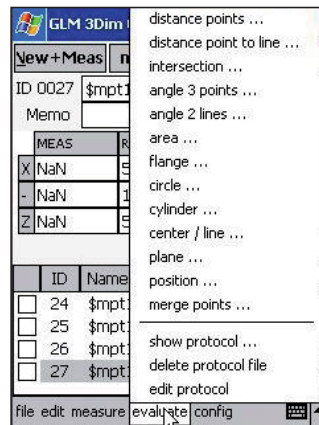

Example: Analyses



Surveying pipe geometries

Measuring in Two Face Positions

Points can be measured in two face positions to increase the accuracy of a measuring observation.

Dynamic Log

Analysis functions are logged in an HTML file and can be used as templates for series measurements. Simply measure the required points and all analyses are carried out automatically. A subsequent change - at the beginning of an entire series of diverse analyses, for example - is automatically considered with all other logged analyses. The dynamic log can be edited at any time. A comment can be added to each individual analysis.

Wireless Communication

The wireless communication between Sokkia Total Stations and the 3-DIM Observer was realized with Bluetooth technology. Our complete systems are easier to use than ever before.

Measure and Find

You have 100 target points in memory and wish to monitor these points. Which target coordinate belongs to which monitoring point? Your points are processed quickly and easily thanks to the new MEASURE AND FIND function. The software searches for the matching target value for your measurement.

After checking the differences, just confirm the save action. Now measure the next point ... and the correct target coordinate is found once again and matched with your measured value. These steps can be automated in connection with the NET1.

Series surveys of wind energy plants



Motor Control with 3-DIM Observer Motorized



these points by pressing a button. The Observer is now ready to scan hundreds of your calculated points automatically. You have two different options:

Scanning Nominal Coordinates with Automatic Nominal/Actual Analysis

The instrument automatically focuses on the selected points. The points can be generated directly in the Observer or imported from external sources. One reflectorless measurement and saving of the coordinates are carried out each time. Deviations from the nominal value are calculated and displayed immediately. Points outside of the tolerance are highlighted.

Iterative Scanning of Nominal Coordinates with Automatic Nominal/Actual Analysis

The instrument scans your component fully automatic and within a predefined tolerance. You can also directly enter any known nominal dimensions of a component to be scanned. These nominal positions are automatically determined and logged with the reflectorless measuring technology. The instrument searches for the desired nominal position until your predefined tolerance window has been reached. This method makes it possible to measure nominal points with an accuracy of 1/10 mm.

In addition to all functions of the 3-DIM Observer, the following modules are available to you for controlling all motorized Sokkia stations.

Generating Nominal Data for the Automated Scanning of Areas and Shapes

Measure the contour of an area to be scanned without using reflectors. Select the increment between the points to be scanned. Generate

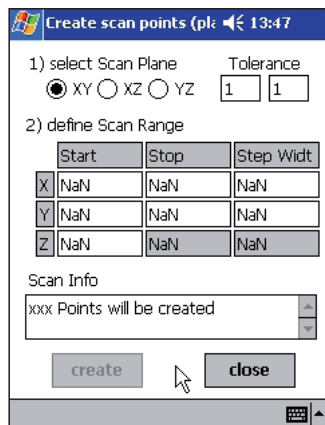

Example: Generate scan points

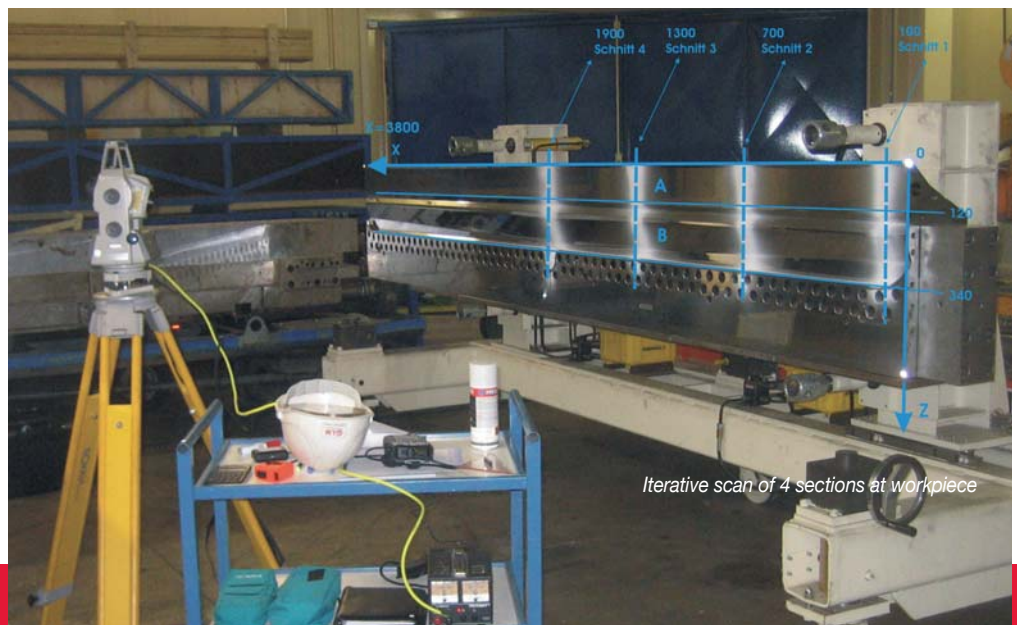

Iterative scan of 4 sections at workpiece

Monitoring with Sokkia Motorized Stations

Available immediately, all motorized Sokkia stations are able to survey automatically different prisms or reflecting foils on buildings to be monitored. Just determine the targets once using 3-DIM Observer Motorized or enter nominal values. Use this nominal data list to carry out fully automatic repeat measurements at any time. The nominal data list may comprise several hundred points! The station automatically focuses on all targets, independently searches for the center of the target, and compares with the nominal values. The measuring system is able to observe and compare an almost unlimited number of measurements on n-points without any user intervention. Comparative analyses are realizable in the sub-mm range.

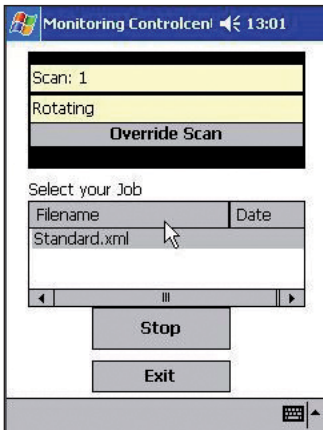

Example: Monitoring

Iterative Marking of Nominal Coordinates

3-D points can be iteratively scanned as well as staked out or marked. The instrument searches for its nominal position until a predefined tolerance window has been reached. For example, it is possible to determine highly precise ground points for an engine bed regardless of ground waves. The laser pointer shows you the exact surveying point in x and y. Minutes of manually searching for the best survey positions is no longer necessary.



Iterative 3D stake-out on curved surfaces

Systematic Cost Reduction

The following Sokkia stations are supported:

Current instruments:

NET1, NET1200, SRX, and SET230R

Previous generation instruments:

NET2, NET2A, NET2B, NET2100, NET1200, and NET1100M

Many instrument functions are supported (depending on instrument):

- Laser pointer on/off
- Target illumination on/off
- Target type: reflectorless/prism/adhesive foil
- Tilt compensator on/off, especially important for working on moving ground or surface (e.g. floating dock)!
- Correction parameters (temperature / pressure, etc.)

Data Management

- Automatic generation of file name, file format: CSV
- Automatic save function during surveying protects from data loss
- Data transfer from/to 3-DIM PC-Basic software via the USB port or SD memory card
- Converting measured data to nominal data
- Generating templates from measured data

Hardware

- 3-Dim Observer is based on current PocketPC technology
- For additional information, please download the current datasheet from www.glm-laser.com

PICTOR-3D

NET1200



Data logger



PC-Software

PICTOR-3D

Automatic visualization of analyses of the data logger 3-DIM Observer

Graphic view:
Direct import of Observer file to Pictor-3D

Table view:
Direct import of Observer file to Excel

CAD Software

CAD-Software

- AutoCAD
- CaDdy
- GeoVision
- Mapsuite+
- Tribon
-

File Format

- *.dwg
- *.dxf
- *.igs
- *.stp
- *.asc
- *.txt
- *.csv
-

NET1



The analysis carried out with 3-DIM Observer (e.g. cylinder) can be depicted on your PC as a graphic for further processing just by pushing a button.

Automatic Drawing of Measured Objects Analyzed with 3-DIM Observer:

The following analyses are supported:

- Points
- Circles
- Flanges
- Center of gravity
- Straight lines
- Frustum of a cone
- Pipe systems
- Poly-lines
- Cuts
- Planes
- Curves

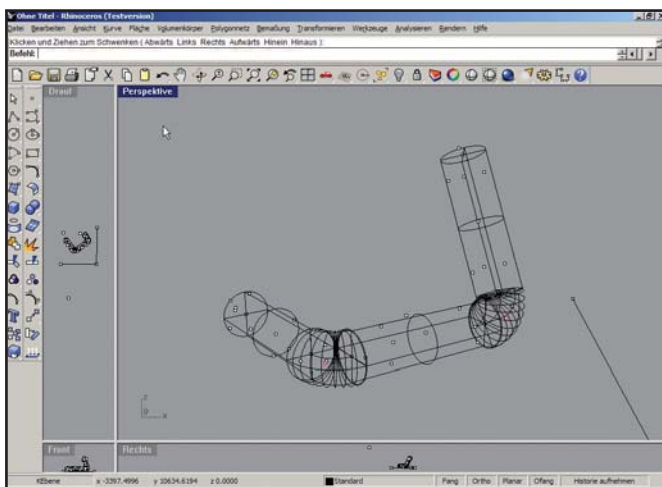

Pipe system after analyses in 3-DIM Observer

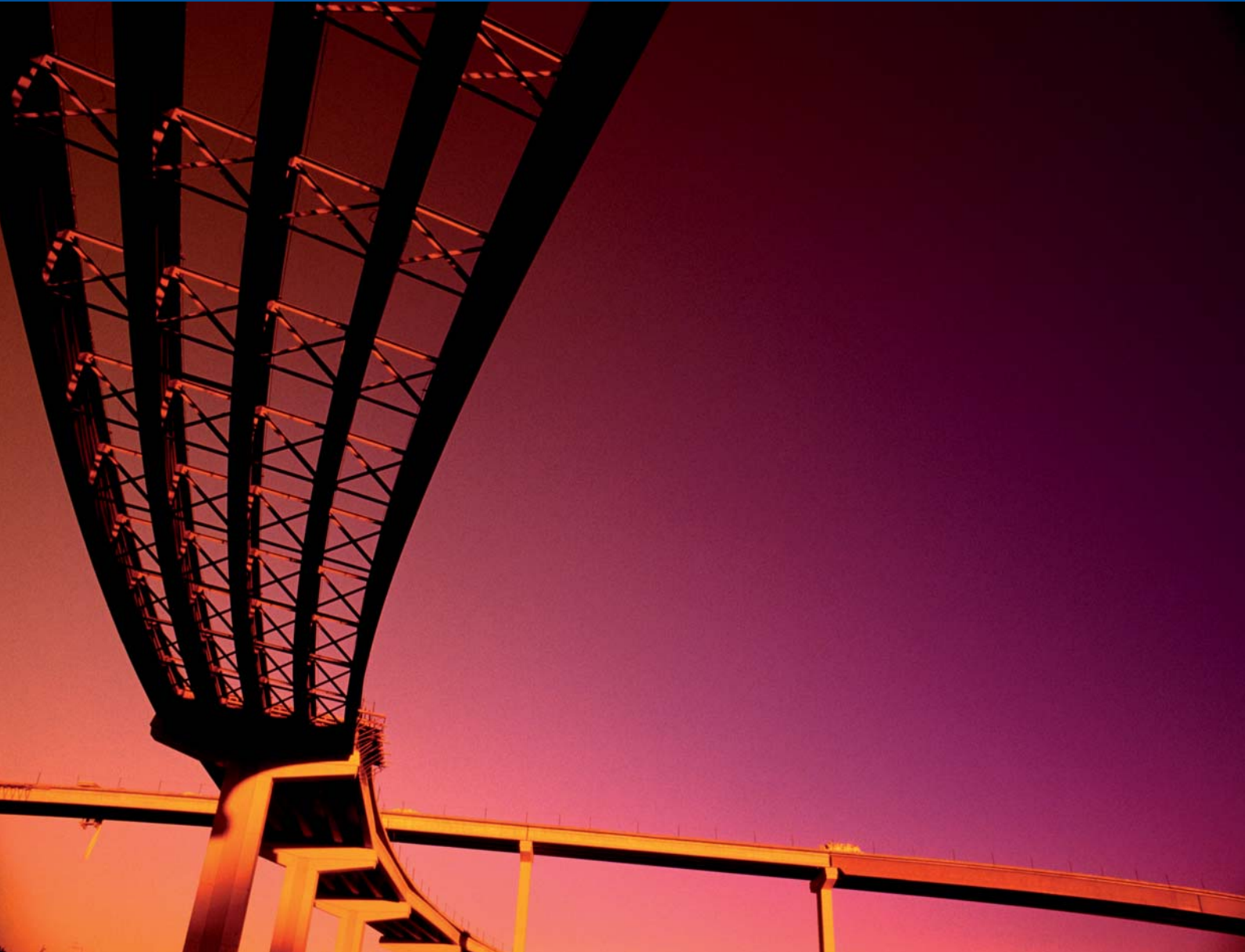

3-DIM CAD-Port is a Plugin for McNeill's Rhinoceros NURBS Modeling Software. Pictor-3D is a Plugin for McNeill's Rhinoceros NURBS Modeling Software. Rhinoceros is a registered trademark of Robert McNeel & Associates.

GLM Lasermeßtechnik GmbH

Stockumer Straße 28

58453 Witten, Germany

Tel.: + 49 (0) 2302 20 399 30

Fax: + 49 (0) 2302 20 399 51

e-mail: info@glm-laser.com

www.glm-laser.com

